

FF13

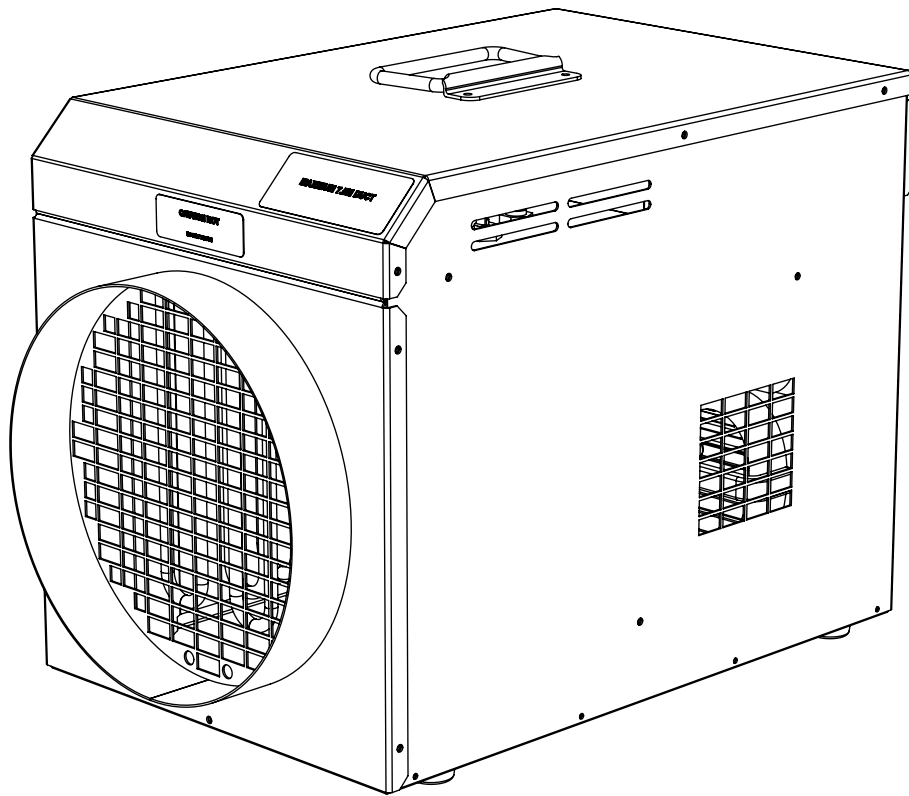

FF13-22
3 PHASE 400V ELECTRIC HEATER
PRODUCT MANUAL

CONTENTS:

Warnings -----	P3
Technical specifications -----	P4
Set-up and operation -----	P5
Using flexible ducting -----	P6
Protective/ safety devices -----	P7-8
Exploded drawing -----	P9
Spare parts -----	P10
Maintenance and fault finding -----	P11
Wiring diagram -----	P12

WARNINGS

These instructions should be read by:

**The specifying engineer.
The installation engineer.
The user.
The service engineer.**







- **Failure to follow these instructions may result in risk of personal injury or damage to the equipment.**
- **Damage due to a failure to follow these instructions will invalidate the warranty.**
- **The appliance must be commissioned & serviced by qualified engineers in compliance with local regulations.**
- **The appliance must be switched off and disconnected from the power supply before any work is carried out.**
- **There are no user controls inside the appliance casing.**
- **Do not place anything on top of the appliance.**
- **Do not use in the vicinity of a pool, bath or shower.**
- **An air gap of at least 300mm should be allowed at the sides of the unit to ensure a clear airflow. Do not site the unit close to soft fabrics or combustible materials.**
- **Allow the unit to cool by running fan only for a minimum of 5 minutes before switching off.**
- **This is a class 1 product and requires an Earth connection.**
- **Do not disconnect the appliance from the supply under load.**
- **For internal use only. Do not use out of doors.**
- **Extension cables should be correctly rated for the load, fully unwound and never run through water or over sharp edges.**
- **This unit can operate with a maximum of 7.5m of 250mm duct or a TOTAL combined length of 10m for 2x 150mm ducts. Ducting should be kept as taught and straight as possible.**
- **The machine is not phase rotationally sensitive.**
- **Do not use this appliance with plastic ducting.**
- **This is a stationary appliance and is not to be moved when connected to the power supply.**

TECHNICAL SPECIFICATIONS. FF13-22	
Heating capacity.	9 kw
Power supply.	400v. 3P+N+E. 16A. 50Hz.
Maximum running current.	12.2A
Airflow.	830m ³ h
Weight.	15.4 kg
Noise level at 3m.	69 dB(A)
IP Rating.	IP20
Maximum operating temperature.	40 °C +/- 3°C
Maximum ducting length (250mm duct) See P6.	7.5m
Maximum ducting length (2x150mm duct) See P6.	10m Total
Temperature rise at 19 °C ambient. (Nominal)	45 °C*

* Outlet temperature taken at the grill.

Standards applied:

BE EN 12100. 2010.
 BS EN 60335-1. 2012.
 BS EN 60335-2. 2009+A11:2012.
 BS EN 61000.

MACHINE AND INSTRUCTION ICONS	
	Important information
	Warning. In order to avoid overheating, do not cover the heater.
	Fan on/off
	Heat setting on/off
	Risk of electric shock. Isolate from power supply before removing cover.

Optional extras:

The FF13-22 can have a twin 150mm spigot outlet as an optional extra. This will allow the unit to run up to a combined total length of 10m of 150mm diameter ducting.

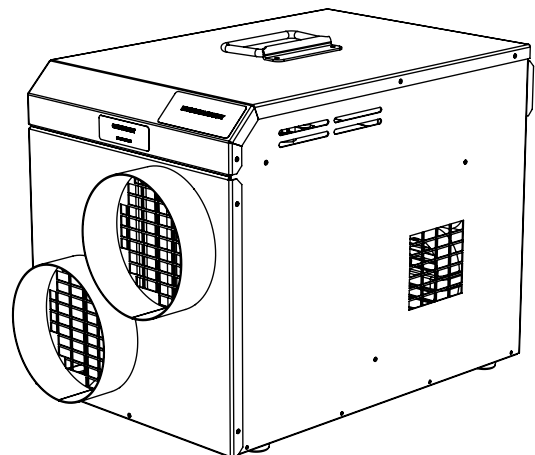

Specifications:

The FF13 is a 9Kw 3 phase industrial electric fan heater.

The appliance is connected to a 16Amp 3P+N+E 50Hz power supply and comes fitted with the appropriate plug.

The machine is not phase rotationally sensitive !

The FF13 is fitted with a high quality forward curved motorised impellor which will allow it to operate with up to 7.5m of 250mm duct. When using twin 150mm ducts, both ducts should not exceed 10m total. **DO NOT EXCEED THESE DUCT LENGTHS!**

The FF13 is fitted with an internal thermostat as standard.

Setup and operation:

To start:

- Please note ! the control panel is at the rear of the appliance. (See P7)
- Site the appliance on a firm level working surface or floor.
- connect to a 16 Amp 400v 3P+N+E 50Hz power supply.
- Switch the fan rocker switch to I. (please note! the heater rocker switch will not operate the heating elements unless the fan switch is on).
- Switch the heater rocker switch to I.
- Set the thermostat to the desired temperature.

To stop:

- Switch the heater rocker switch to 0 and allow the fans to run for a minimum of five minutes to cool the machine. Failure to follow this procedure may cause the safety limit thermostat to nuisance trip and damage sensitive components. This will invalidate the warranty.
- Switch the fan rocker switch to 0 when the heat has dissipated.
- If the heater is not in regular daily use disconnect from the power supply.



Using flexible ducting:

- This appliance is designed to be operated with a maximum flexible duct length of 7.5m.
- 250mm ducting should be fitted. Do not use reducers. Where twin 150mm ducts are used the total length of the combined ducts should not exceed 10m.
- Aluminium foil duct is recommended. Do not use plastic flexible duct.
- Always keep duct lengths to a minimum.
- Always keep duct runs as straight as possible.
- Poorly run flexible ducting can cause overheating of the machine. Do not run ducting through 180 degrees.

Acceptable duct runs:

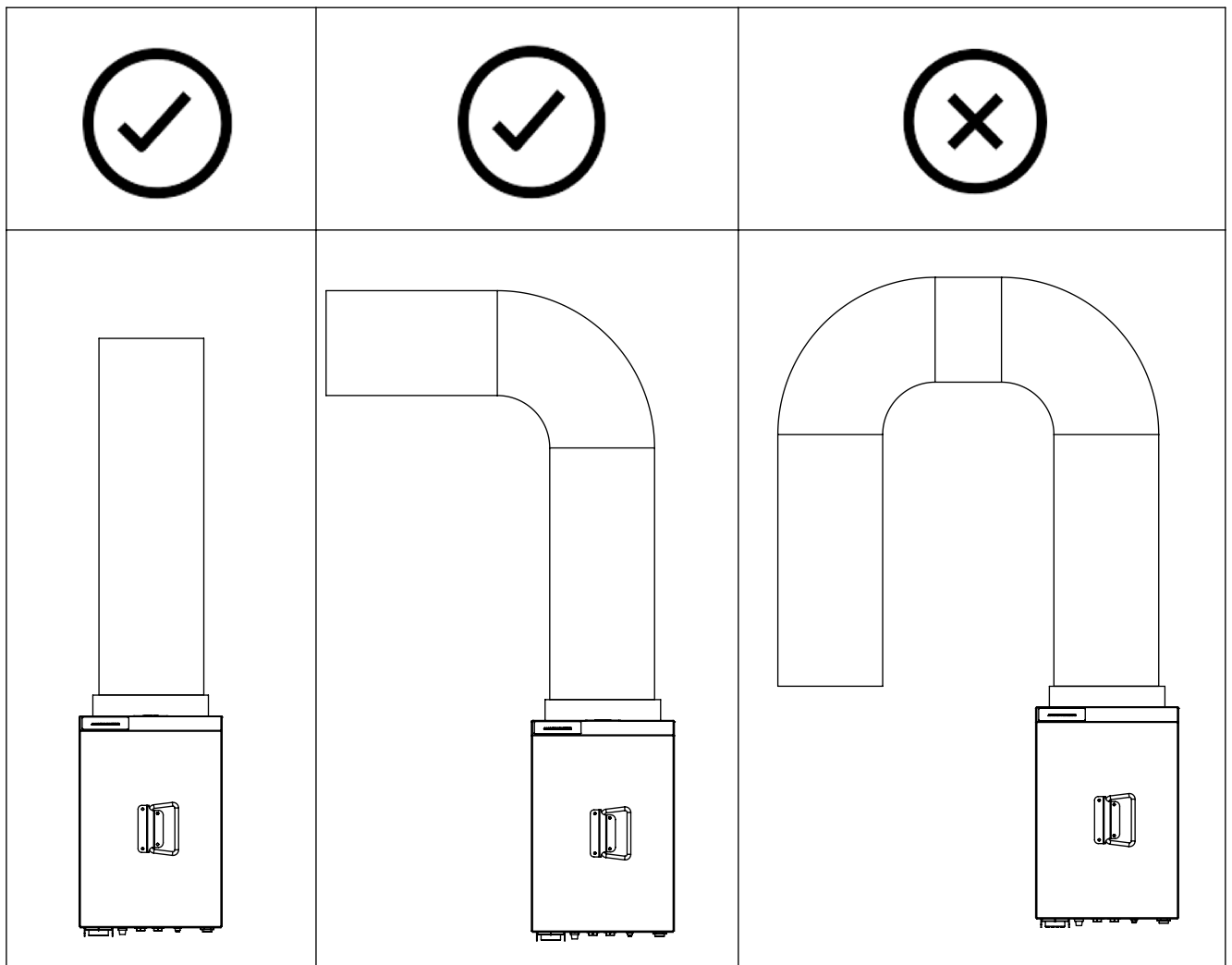

Protective /safety devices:

- The FF13 is fitted with a safety limit thermostat. This is a fail-safe device. Should the maximum design operating temperature be exceeded it will shut down the heating elements and leave the fan running. This device requires a manual reset and should only operate in the event of a fault. Any activation of this safety device should be investigated by a competent engineer.

IT SHOULD BE NOTED! Failure to shut the machine down correctly can cause this device to nuisance trip. See P5.

- The FF13 is fitted with a limit thermostat. Should the maximum operating temperature be exceeded it will shut down the heating elements and leave the fan running. This device will automatically reset once the temperature falls to an acceptable level.
- The control circuit is protected by a 7A circuit breaker.

Control panel:

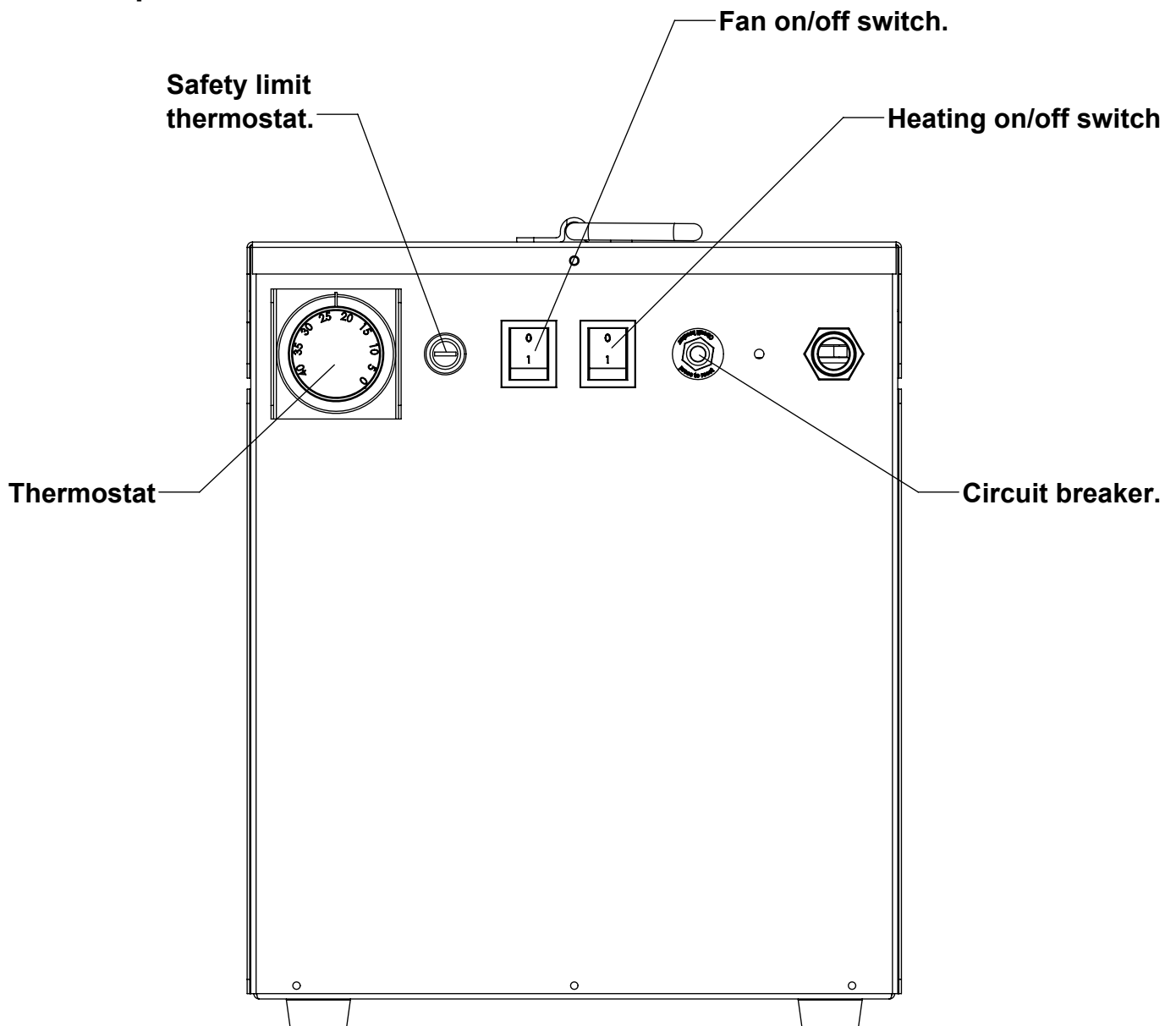

Safety limit thermostat:

Checking and resetting the safety limit thermostat:

Should the safety limit thermostat activate the causes should be investigated.

- **Remove the black plastic screw cover from the safety limit thermostat. (See P7)**
- **If the reset button is noticeably pronounced the reset has activated.**
- **To reset the thermostat press the reset button. Allow the machine to fully cool down before resetting.**
- **Always replace the screw cap after resetting.**
- **Nuisance tripping of this device can occur if the correct shut-down procedure is not followed.**

Exploded view:

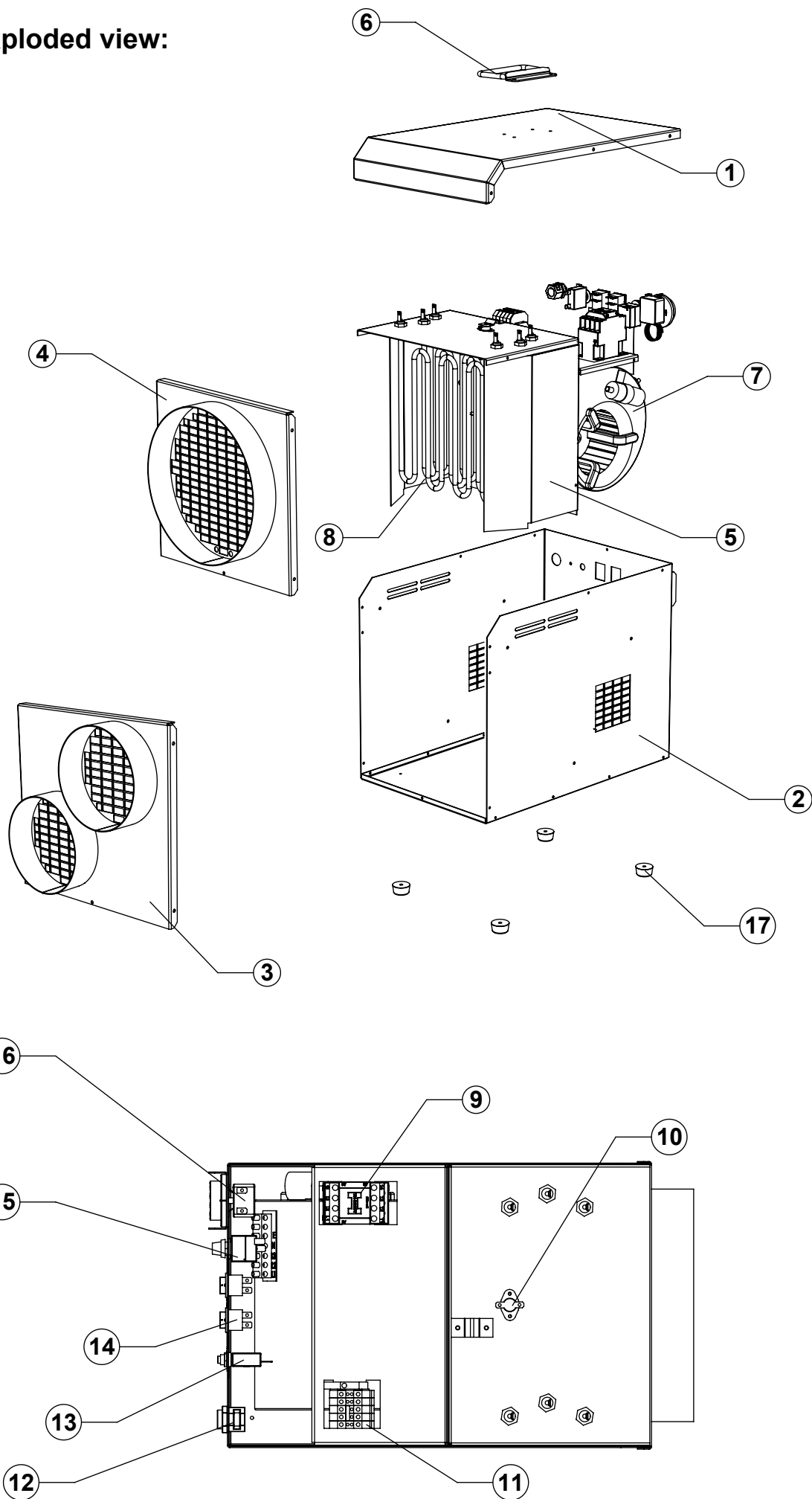

Spare parts:

Item No	Part description	Part No
1	Top panel	BW010216
2	Case	BW011007
3	Front panel. Twin spigot. (Optional)	BW010625
4	Front panel. Single spigot.	BW010624
5	Galvanised metalwork set.	BW0202132
6	Trunk handle	ME040316
7	133 AC fan motor.	FA010303
8	Heating element.	HE010114
9	Contactora. 9/25A. 230v Coil.	EL010232
10	Thermal switch. 80°C.	EL010301
11	6mm Terminal assembly.	EL020424
12	Cable gland c/w lock nut.	ME040204
13	Circuit breaker. 7A.	EL010235
14	0/1 Rocker switch.	EL0303235
15	Safety limit thermostat.	EL030417
16	Thermostat c/w Knob and bezel.	EL030409
17	Rubber foot.	ME040315
18	Power lead. 1.5mm ² 5 pin 16A. (Not shown).	EL020135

Maintenance:

Always isolate the machine from the power supply before carrying out any maintenance.

Fan motors, elements and switch gear are not customer serviceable components. General maintenance should include regular inspection of:

- 1: Mains cable. Check for signs of damage to the insulation. Replace if necessary.
- 2: Air intake & outlet grills: ensure grills are free from accumulated debris. blow out with compressed air if required.
- 3: Fixings: Check all fixings are present and secure.

Maintenance carried out by a competent person:

- 1: Internal cables should be inspected for signs of heat damage and replaced when necessary.
- 2: All cable connections should be regularly checked and tightened. Particular attention should be paid to the connections at the contactors.
- 3: Regularly check the contactors for signs of heat. Replace if necessary.

Fault finding:

FAULT	POSSIBLE CAUSE	SOLUTION
NO HEAT OUTPUT.	FANS AND OR HEATING NOT SWITCHED ON.	CHECK ALL SWITCHES ARE ON.
	THERMOSTAT INCORRECTLY SET.	TURN THERMOSTAT KNOB FULLY CLOCKWISE.
	SAFETY LIMIT THERMOSTAT ACTIVATED.	RESET. INVESTIGATE CAUSE. SEE P8.
	POWER SUPPLY INTERRUPTED.	CHECK POWER SUPPLY.
	FAULTY ROCKER SWITCH.	CHECK SWITCHES AND REPLACE IF NECESSARY.
	FAULTY THERMOSTAT.	CHECK THERMOSTAT AND REPLACE IF NECESSARY.
	FAULTY CONTACTOR.	CHECK CONTACTOR AND REPLACE IF NECESSARY.
FAN MOTOR NOT RUNNING.	POWER SUPPLY INTERRUPTED.	CHECK POWER SUPPLY.
	FAULTY ROCKER SWITCH.	CHECK SWITCHES AND REPLACE IF NECESSARY.
NO FAN OR HEATING. POWER SUPPLY GOOD	CIRCUIT BREAKER HAS TRIPPED.	INVESTIGATE THE CAUSE AND RESET THE CIRCUIT BREAKER.
SAFETY LIMIT THERMOSTAT HAS ACTIVATED.	MACHINE INCORRECTLY SHUTDOWN. (SEE P5)	ALLOW THE MACHINE TO COOL AND RESET THE THERMOSTAT. (SEE P-8)
	DUCT RUN INCORRECT OR EXCESSIVE DUCT LENGTH FITTED.	ADJUST DUCTING AND RESET THERMOSTAT. (SEE P-5)
	FAN MOTOR FAILURE.	REPLACE FAN MOTOR. RESET THERMOSTAT.
TEMPERATURE RISE INSUFFICIENT.	THE MACHINE SHOULD DELIVER A TEMPERATURE RISE OF APPROXIMATELY 40°C ABOVE THE AMBIENT TEMPERATURE. SHOULD THE MACHINE FAIL TO DO THIS CHECK THE POWER SUPPLY AND THAT THE THERMOSTAT IS TURNED FULLY CLOCKWISE. IT SHOULD BE NOTED THAT THE MAXIMUM AMBIENT TEMPERATURE THE MACHINE WILL RUN AT IS 40°C +/- 3°C.	

FF13-22 WIRING DIAGRAM. 01.04.2022

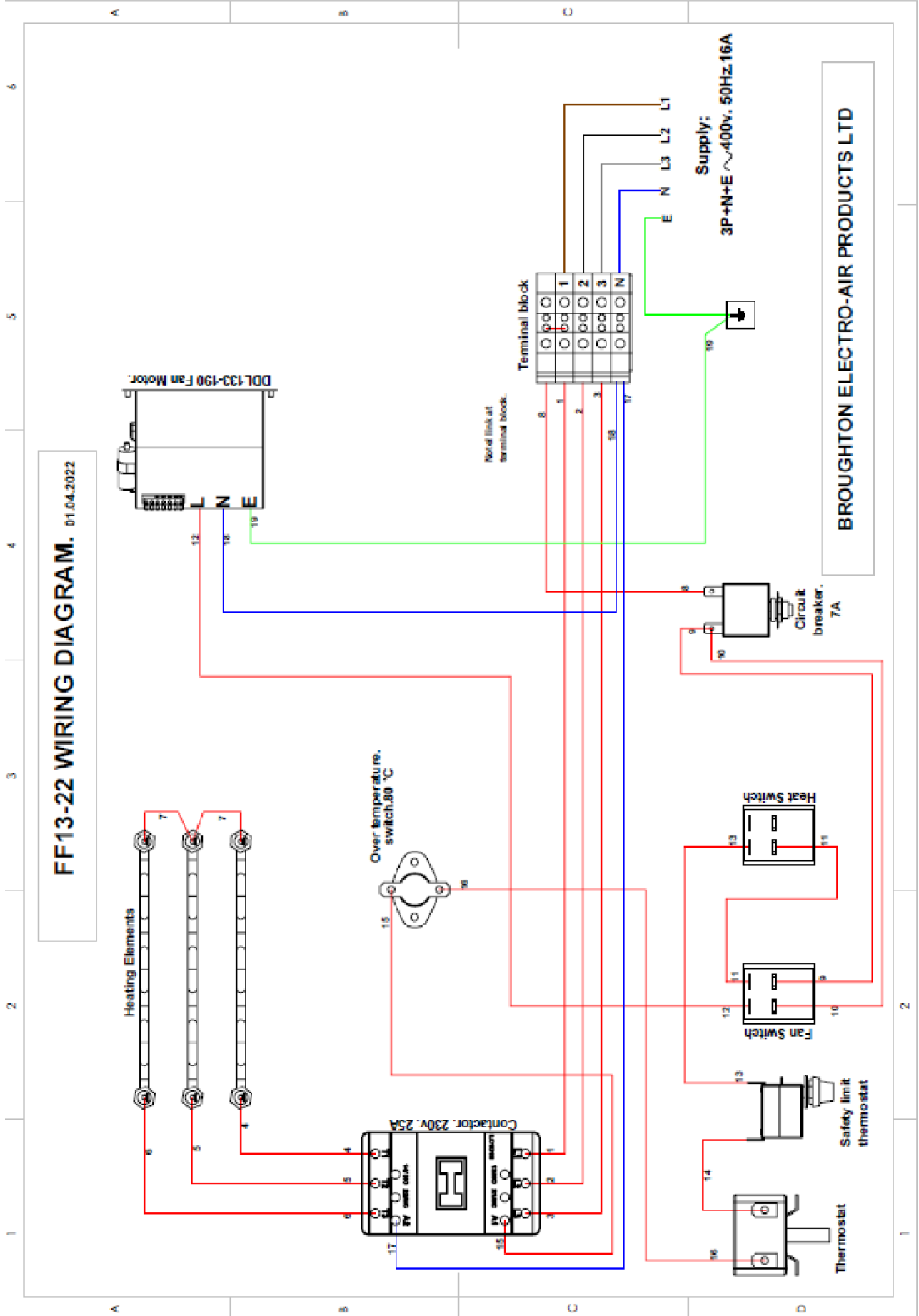

BROUGHTON ELECTRO-AIR PRODUCTS LTD