

CT 570  
CTD 570  
CT 750  
CTD 750  
CT 900  
CTD 900

# Numatic

numatic.com



**We & Dry  
Extraction**

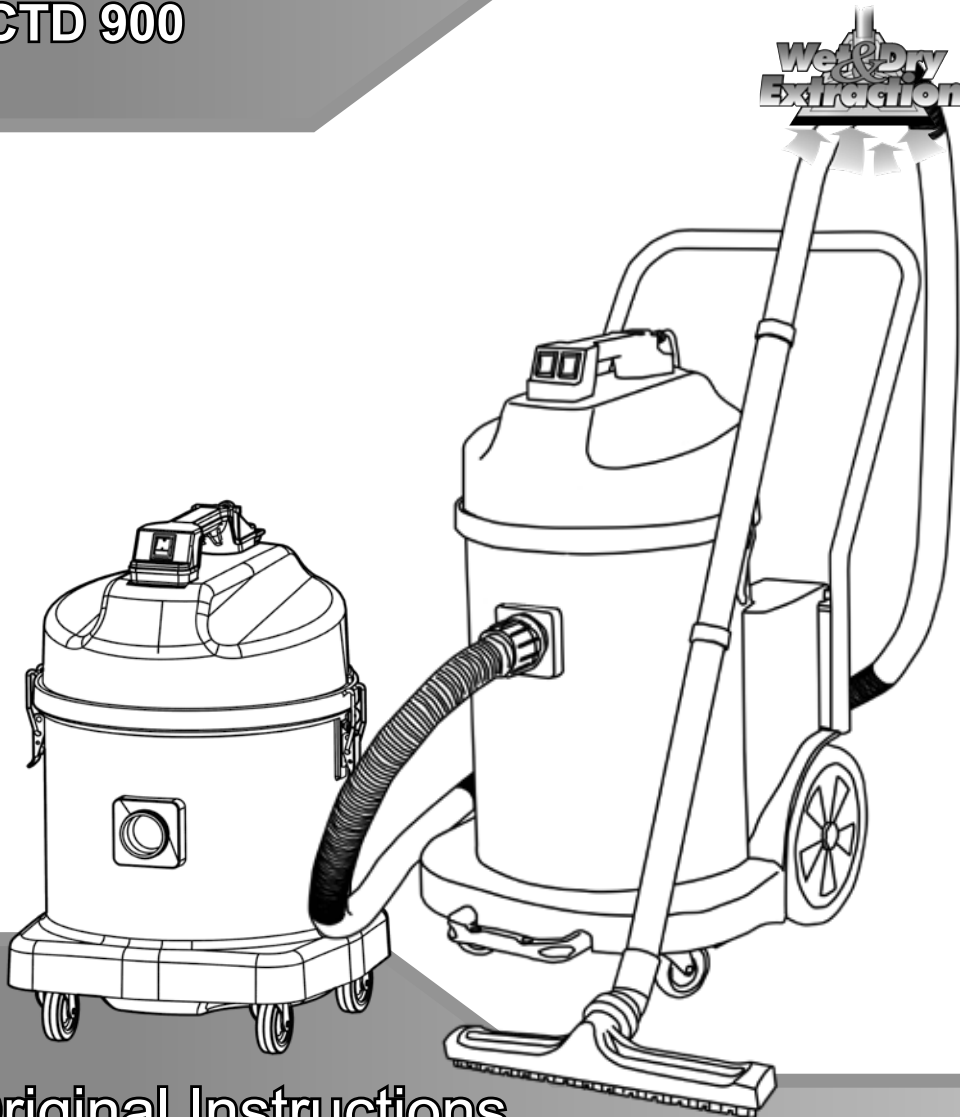

## Original Instructions

CAUTION, Read the Instructions before using the machine.

# Machine, Kits and Bags

WET - Kit A41A

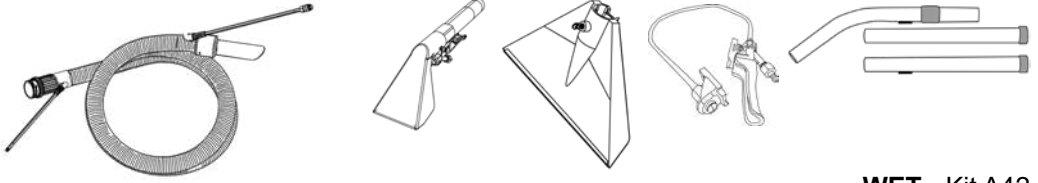

WET - Kit A42



WET - Kit A40A

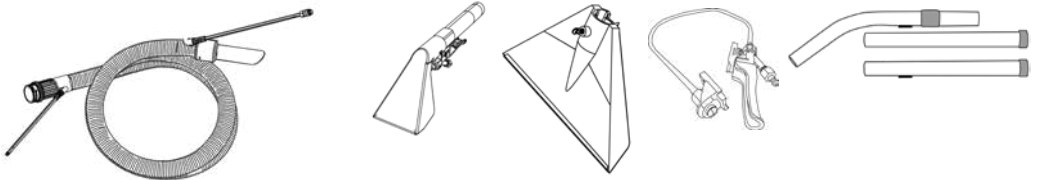

Optional Extra's DRY - Kit A44

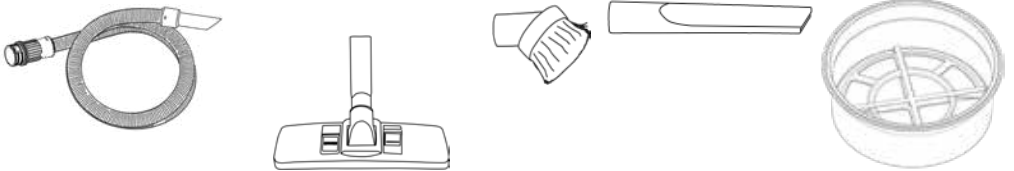

**Hepaflo Bags**  
Dry use only

**Permatex Filter**  
Dry use only

570 Drum  
NVM 3BH (604017) x10  
Master Carton 10x10 (604817)

750 / 900 Drum  
NVM 4BH (604019) x10  
Master Carton 6x10 (604819)

NVM- 604116  
Primary Permatex Filter  
for 365mm Machine



# Handle Assembly

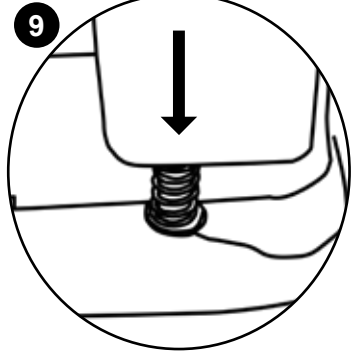
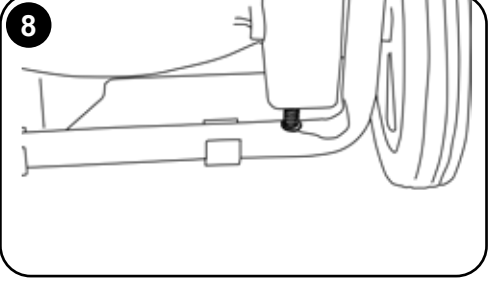
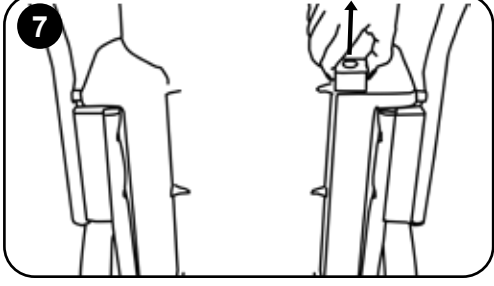
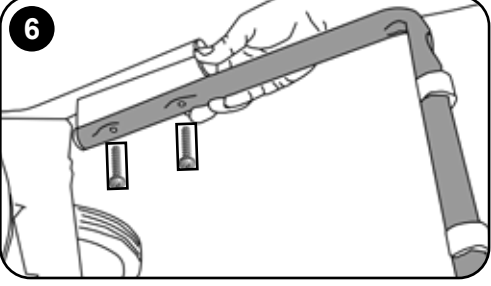
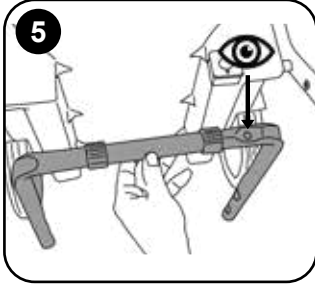
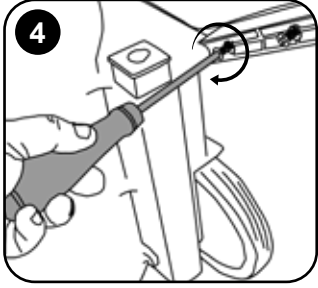
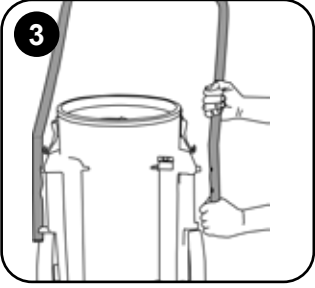
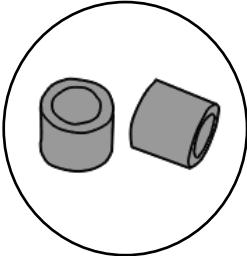
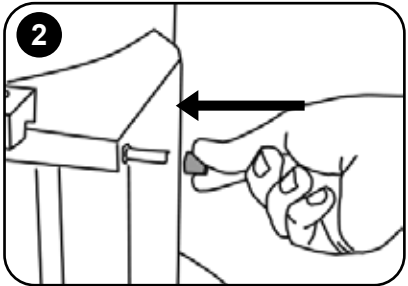
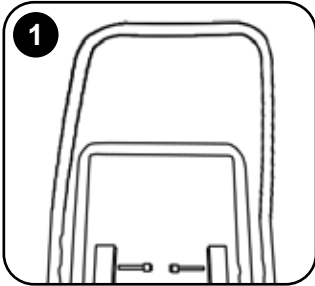

**CT 900**  
**CTD900**

# Wet - Assembling the machine for extraction use

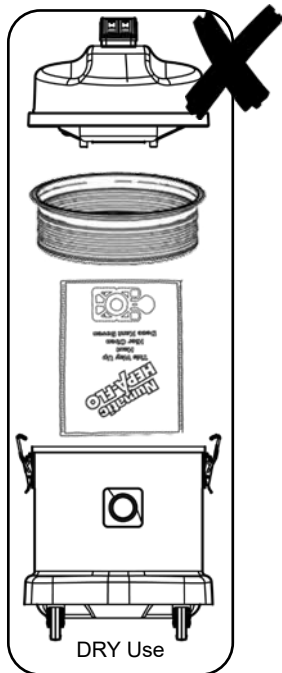

Cold Water



## Nuchem 4 Dosage

40mls per 5L of cold water

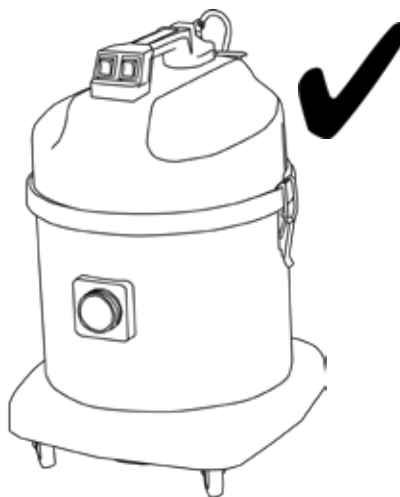
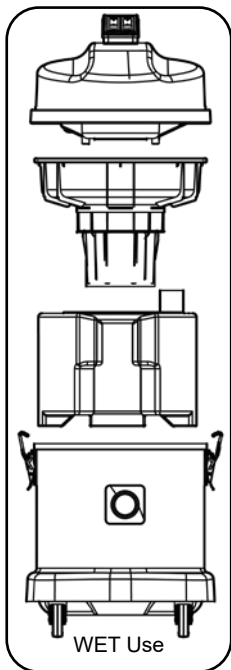
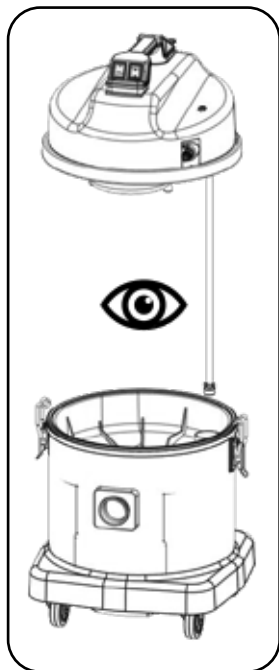
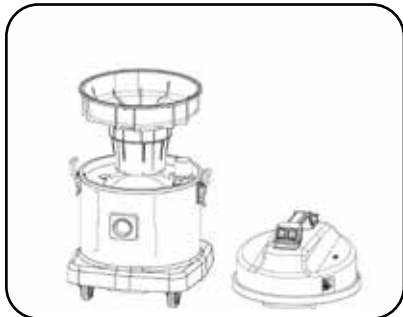
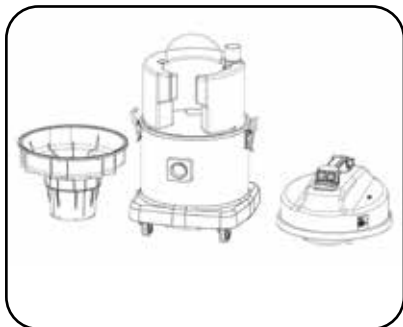

# Wet - Assembling the machine for extraction use

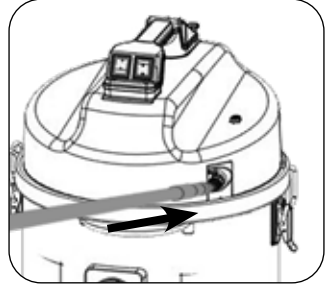
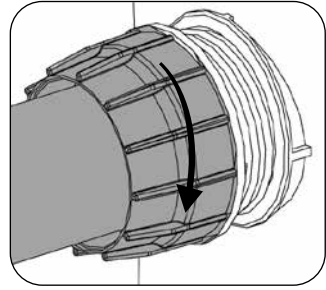
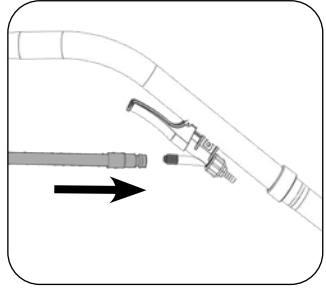
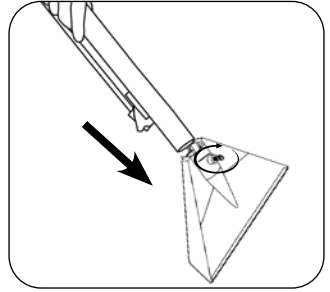
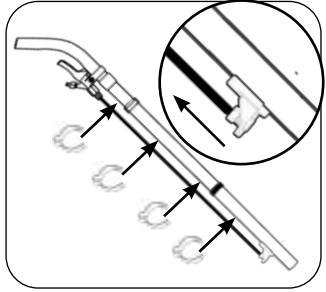
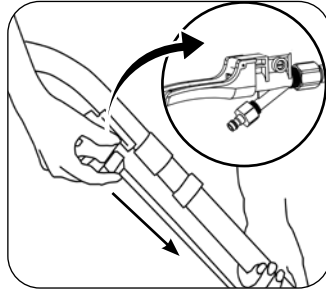
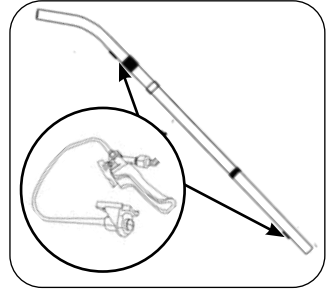
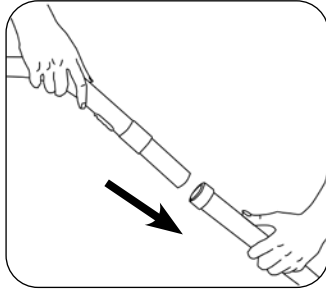
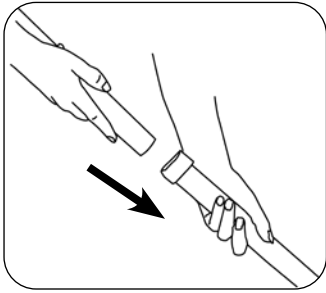

# Wet / extraction - Using the machine

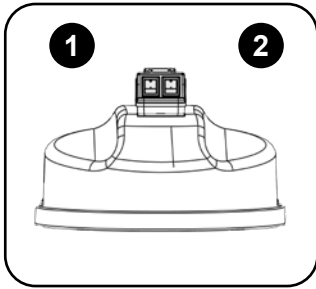

1 Vac

2 Pump

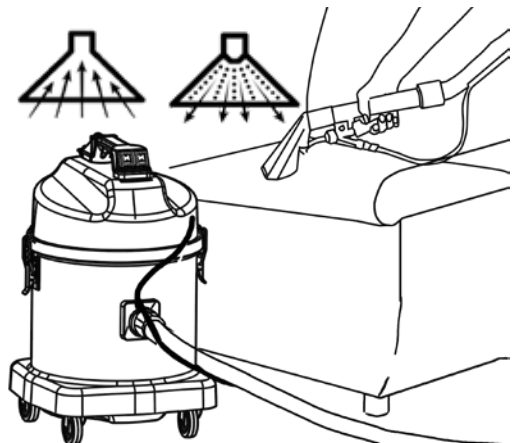
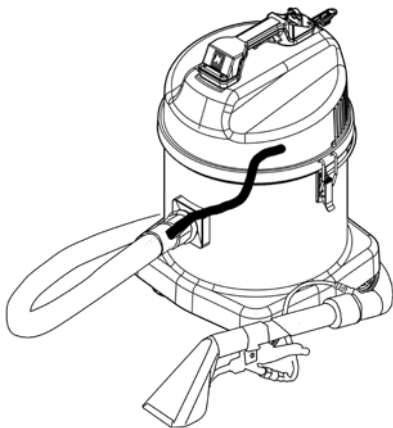
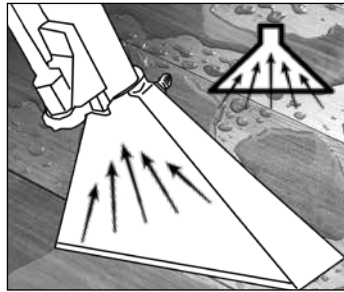
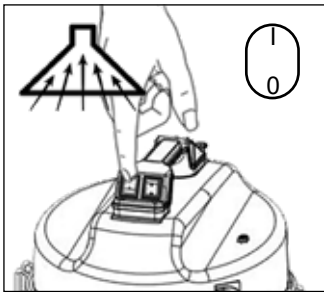
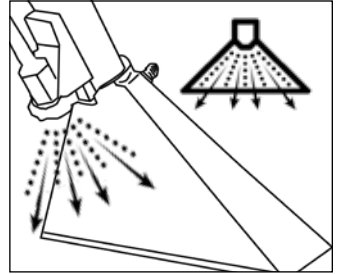
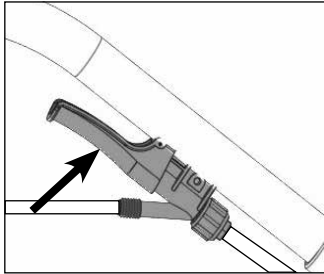
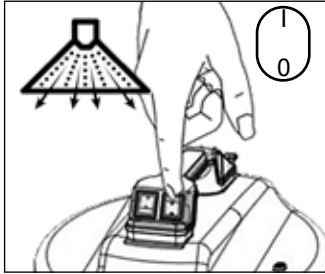

## Emptying your machine

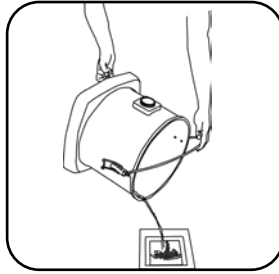
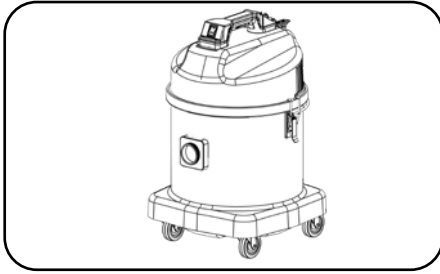

**CT 570**  
**CTD 570**

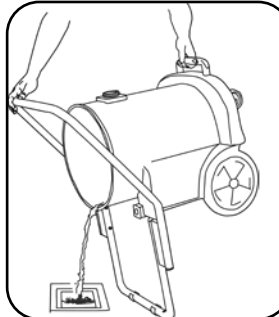

**CT 900**  
**CTD 900**

## Cleaning the machine

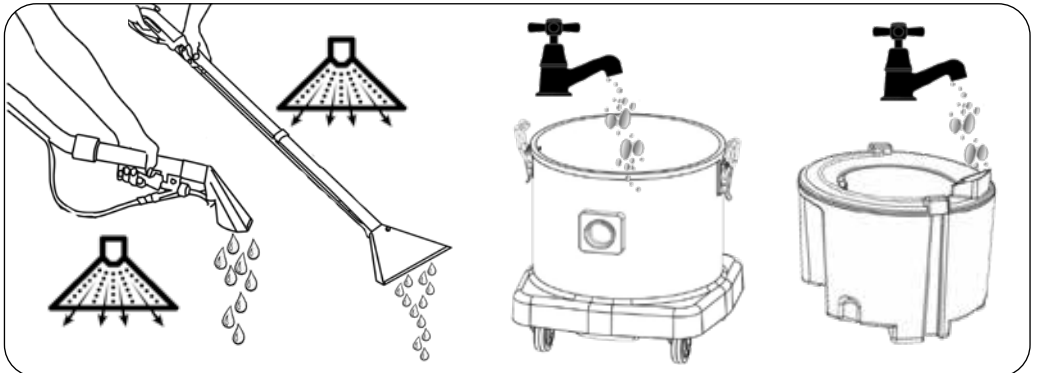
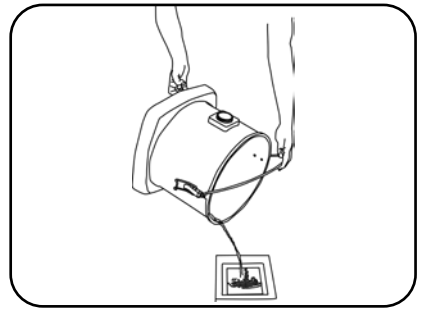
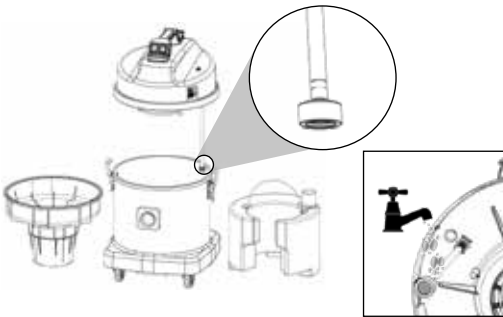

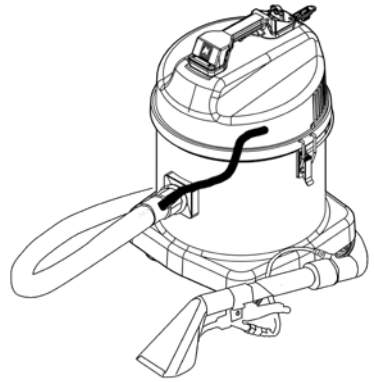
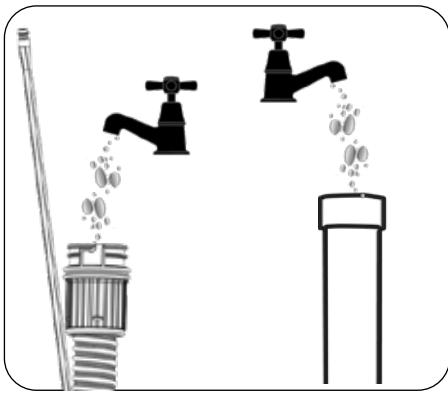

## Dry- Assembling the machine

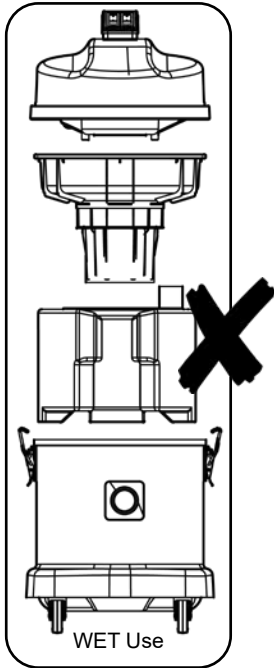

WET Use



DRY Use

## Schematic diagram

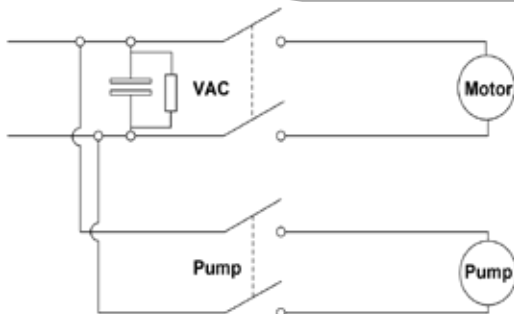



# Changing / Replacing Cable

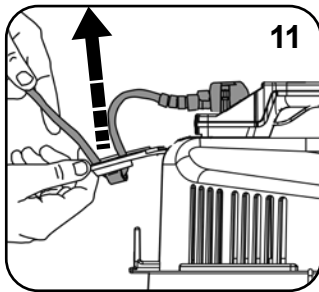
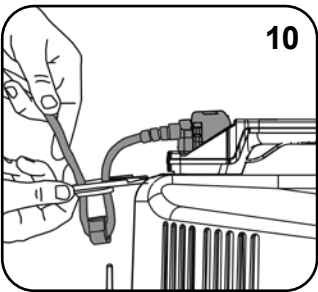
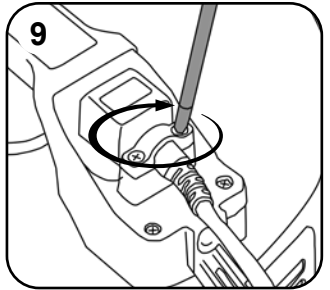
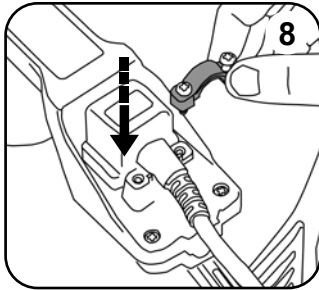
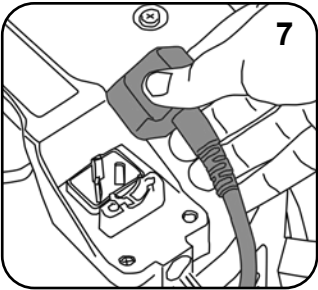
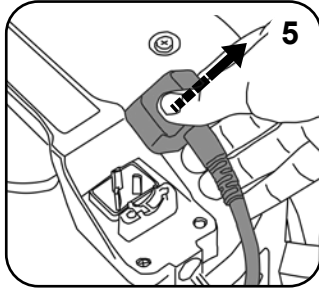
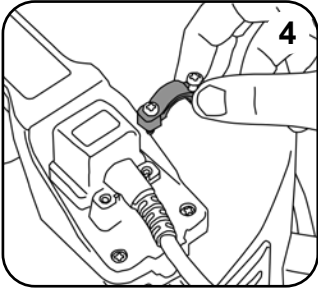
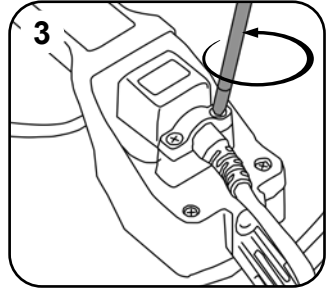
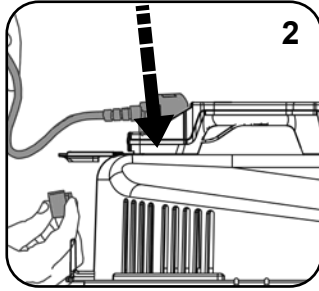
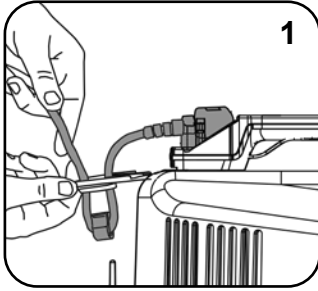

# (GB) About your machine

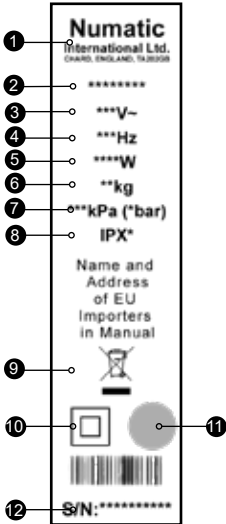

1	Company Name & Address
2	Model
3	Voltage/Alternating Current
4	Frequency
5	Rated Input Power
6	Weight
7	MAX Pressure
8	Ingress Protection
9	WEEE Logo
10	Protection Class 2 Symbol
11	Approval Mark
12	Machine yr/wk Serial Number

## Maintenance

### Daily

Keep the machine clean, including hoses and tubes. Ensure the bag and filter are fitted. Regularly examine the power cord. Check dust bag frequently. Check filters are clean.

### Weekly - as daily and:-

Check for any worn or damaged parts and replace immediately.

### WEEE Legislation (Waste, Electrical and Electronic Equipment)

Vacuum cleaner, accessories and packaging should be sorted for environmentally - friendly recycling.

#### (Only for UK/EU Countries)

Do not dispose of vacuum cleaner into household waste! According to the European Directive 2012/19/EU on waste electrical and electronic equipment and its incorporation into national law.

Vacuum cleaners that are no longer suitable for use must be separately collected and sent for recovery in an environmentally - friendly manner.



### PPE (personal protective equipment). That may be required for certain operations.

Ear Protection	Safety Footwear	Head Protection	Safety Gloves	
				Caution Floor Sign
Eye Protection	Protective Clothing	Dust / Allergens Protection	Hi Viz Jacket	

**NOTE:** A risk assessment should be conducted to determine which PPE should be worn.

Failure to rectify the problem or in the event of a breakdown contact your Numatic dealer or the Numatic Technical helpline +44 (0)1460 269268

### Safety Critical Components

Mains leads: (CT 230V) HO5VV-F x 10 m x 2 Core x 1.00 mm<sup>2</sup>  
(CT 115V/CTD 230V) HO5VV-F x 10 m x 2 Core x 1.50 mm<sup>2</sup>

# Information for Spray / Extraction use Vacuum Cleaners

## Warning

Read the instruction manual before using the machine.

Operators shall be adequately instructed on the use of these machines.

As with all electrical equipment, care and attention must be exercised at all times during use,

in addition to ensuring that routine and preventative maintenance is carried out periodically to ensure safe operation.

Failure to carry out maintenance as necessary, including the replacement of parts to the correct standard could render this equipment unsafe and the manufacturer can accept no responsibility in this respect.

The machine shall be disconnected from the mains by removing the plug from the power supply socket during cleaning or maintenance and when replacing parts or converting the machine to another function.

This machine is not to be used by children or persons with reduced physical, sensory or mental capabilities, or lack of experience or knowledge.

Children being supervised are NOT to play with the machine.

This appliance is intended to be assembled, cleaned and maintained by an adult.

This machine is not a toy.

This machine is not suitable for picking up hazardous or explosive dust. Contact your local distributor if you require a machine capable of performing these tasks.

If foam/liquid comes out of machine exhaust, switch off immediately.

Allow the accumulated liquid to drain out through the machine exhaust, check the float assembly to ensure correct operation, empty the container if full of liquid, reassemble the machine.

Immediately upon start up there will be a certain amount of liquid issuing from the machine exhaust which will be the residue of liquid still within the power head. This will be quickly discharged after which the machine should function normally.

Liquid ejected from the machine could be hazardous as a result of its temperature, pressure or chemical content.

## Caution

Ensure that the filtration system fitted to the machine is suitable for the material being collected.

This machine is for indoor use only.

This machine shall be stored indoors only.

When moving from one place to another, consider the weight of the machine.

## Notes

You must ensure that the filtration system fitted to the machine is suitable for the material being collected.

This product complies with the requirements of IEC/EN 60335-2-68.

This product complies with the requirements of clause 20 of IEC/EN 60335-2-69 for Stability and Mechanical Hazards.

The primary use for this machine is commercial, for example in hotels, schools, hospitals, factories, shops and offices.

If the vacuum cleaner stops working, remove the plug from the power supply before investigating where the fault lies.

The vacuum cleaner should be inspected after use for damage.

The power light will illuminate, when your machine is connected to a suitable power supply (where fitted).

## Do

- Use a bag and filter at all times when using 'dry'.
- Keep your machine clean.
- Keep filters clean.
- Regularly clean the water level limiting float safety valve and examine for signs of damage or correct operation.
- Keep hoses and tubes clear.
- Replace any worn or damaged parts immediately.
- Regularly examine the power cord, if damage is found, the power cord must be replaced by a special cord available from Numatic or its service agents.

## Don't

- Use steam cleaners or pressure washers to clean the machine or use the machine in the rain.
- Immerse in water for cleaning.
- Allow any inexperienced repairs. Call the experts.
- Use wet if float valve is not functioning or fitted.
- Use to suck up hot ashes, or lighted cigarette ends.
- Run the machine over the power cable during operation as a hazard may occur.
- Pull on the cable to unplug the machine from the power supply.
- Walk over-wet carpets, upholstery or fabrics.
- Walk on clean carpets until fully dry.
- Attempt machine maintenance or cleaning unless the power supply plug has been removed from the supply outlet.
- Under any circumstances place foreign objects including (but not limited to) air fresheners, air freshener capsules or scented beads of any type into the top filter of the machine. Doing so can be dangerous and risk damage to the machine and may invalidate the machine warranty.

This machine can be used for dry pick up, wet pick up and cleaning carpet and upholstery

Spray extraction machines only

- Use only approved cleaning preparations.

- Use defoamer if necessary.

Use of detergents

When using any detergent with this machine, please ensure you have read the safety data on the container and you are familiar with the procedures to clear up spills, inhalation, skin and eye contact.

### Dry Mode maintenance/fault finding

If the vacuum cleaner stops working switch off and remove the plug from the power supply before investigating were the fault lies.

If the vacuum cleaner will not pick up any debris from the surface, switch off and remove the plug from the power supply, inspect the floor tool, wands and hose for blockages, if no blockages are found, the dust bag may be full if the dust bag is not full the filter may be blocked.

### Wet mode / Spray extraction maintenance/fault finding

If the vacuum cleaner stops working switch off and remove the plug from the power supply before investigating were the fault lies.

If the vacuum cleaner has a blockage and will not pick up liquid, switch off and remove the plug from the power supply, has the float valve operated, this will shut off the suction and the pitch of the vacuum motor will change.

Remove the power head and empty the liquid out of the container, if the container is empty, check that the floor tool wands and hose are not blocked.

If the spray nozzle is blocked a pin maybe used to clear the blockage.

No spray from nozzle and the pump tone changes, the solution tank is empty, refill the solution tank.

Flush the system with clean water after use.

After use always inspect the machine for damage

## NuChem 4 provided with this product.

### INSTRUCTIONS FOR USE

#### TEST FOR COLOUR FASTNESS

Find an out of the way place which is not normally in view and test the carpet / fabric for colour fastness by rubbing the cloth dampened with correctly diluted NuChem 4.

Do not use on velvet type materials or any materials not suitable for wet cleanin according to fabric manufacturers cleaning instructions.

#### For Normal soiling:

Pour one 40ml Measure into 5 litres of cold water.

#### For Heavy Soiling:

Pour two 40ml Measure into 5 litres of cold water.

*NuChem 4 is non-foaming, bactericidal, contains optical brightners and leaves no tacky residues in the fabric and is enhanced with both a delicate and discreet verbena scent.*

### HEALTH AND SAFETY

#### Caution:

Keep out of the reach of children and pets.

Wear suitable gloves.

Avoid contact with skin and eyes.

In case of eye contact flush with clean water seek medical attention.

In case of contact with the skin rinse with plenty of clean water.



#### CONTENTS:

Composition:

Greater than 30% = among other ingredients water

Less than 5% = SODIUM XYLENE SULPHONATE

CAC: 1300-72-7

Classified as Irritant

[xl] r36/37/38

Risk Phrases: R36 / 38: irritating to eyes and skin

Safety Phrases: S2: Keep out of the reach of children

S24: Avoid contact with skin and eyes

S37: Wear suitable gloves



	1	2	3	4	5
CT 570 CTD 570	1000W 1000W x 2	42 L/sec 96 L/sec	2400 mm w.g.	26.8m	II
	6	7	8	9	10
CT 570 CTD 570	23 Ltrs	15L	415 x 415 x 645 mm	19.0 kg 20.0 kg	77 - 79 dB (A) 0.5dB

	1	2	3	4	5
CT 750 CTD 750	1000W 1000W x 2	42 L/sec 96 L/sec	2400 mm w.g.	26.8m	II
	6	7	8	9	10
CT 750 CTD 750	35 Ltrs	25L	680 x 550 x 940 mm	21.4 kg 23.9 kg	77 - 79 dB (A) 0.5dB

	1	2	3	4	5
CT 900 CTD 900	1000W 1000W x 2	42 L/sec 96 L/sec	2400 mm w.g.	26.8m	II
	6	7	8	9	10
CT 900 CTD 900	40 Ltrs	32L	800 x 490 x 880 mm	25.3 kg 27.8 kg	77 - 79 dB (A) 0.5dB

1	Motor
2	AirFlo
3	Suction
4	Cleaning Range
5	Class
6	Capacity Dry
7	Capacity Wet
8	Size
9	Weight
10	Sound Pressure

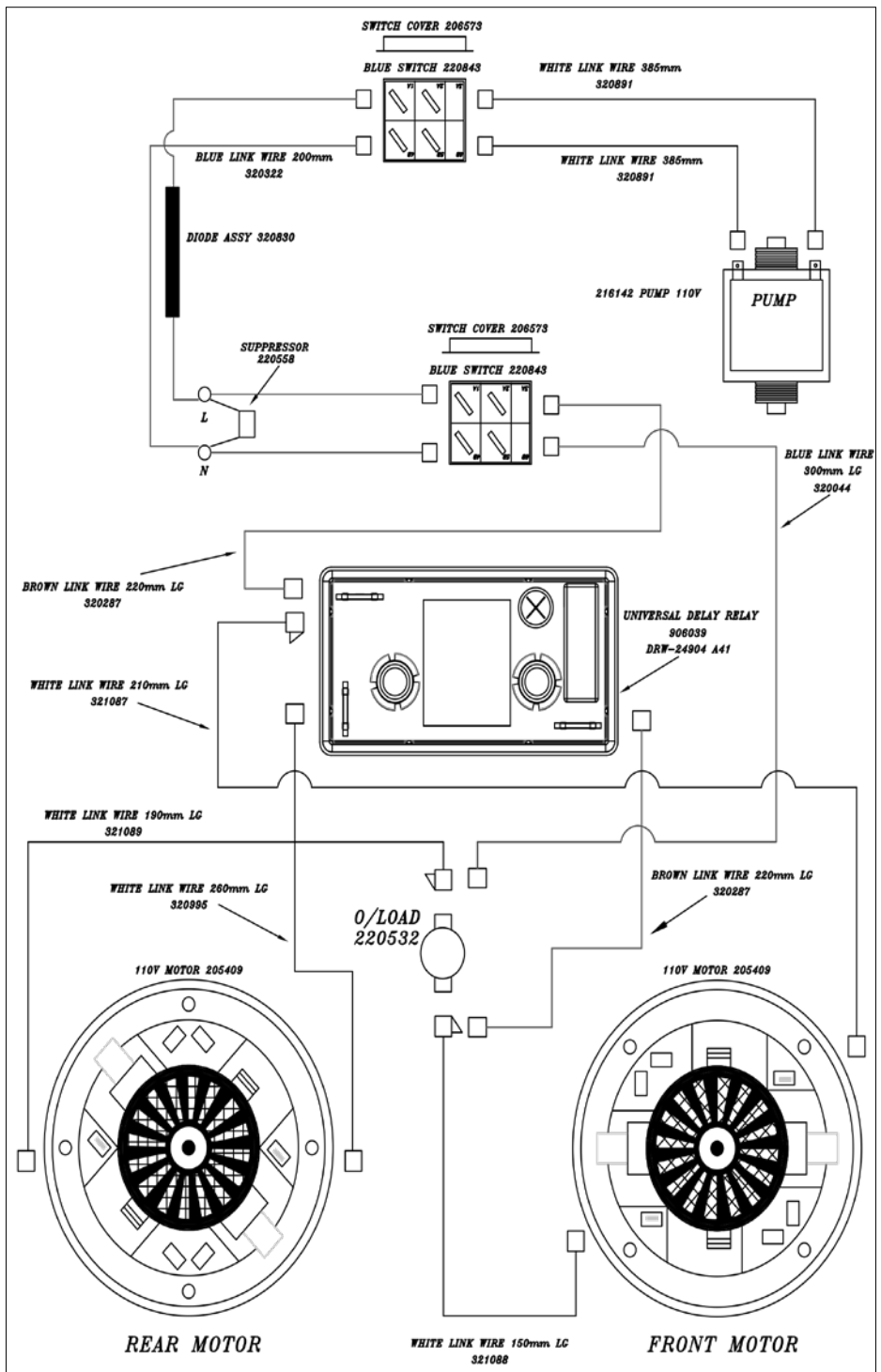

WD-0256 CTD 110V (A03)

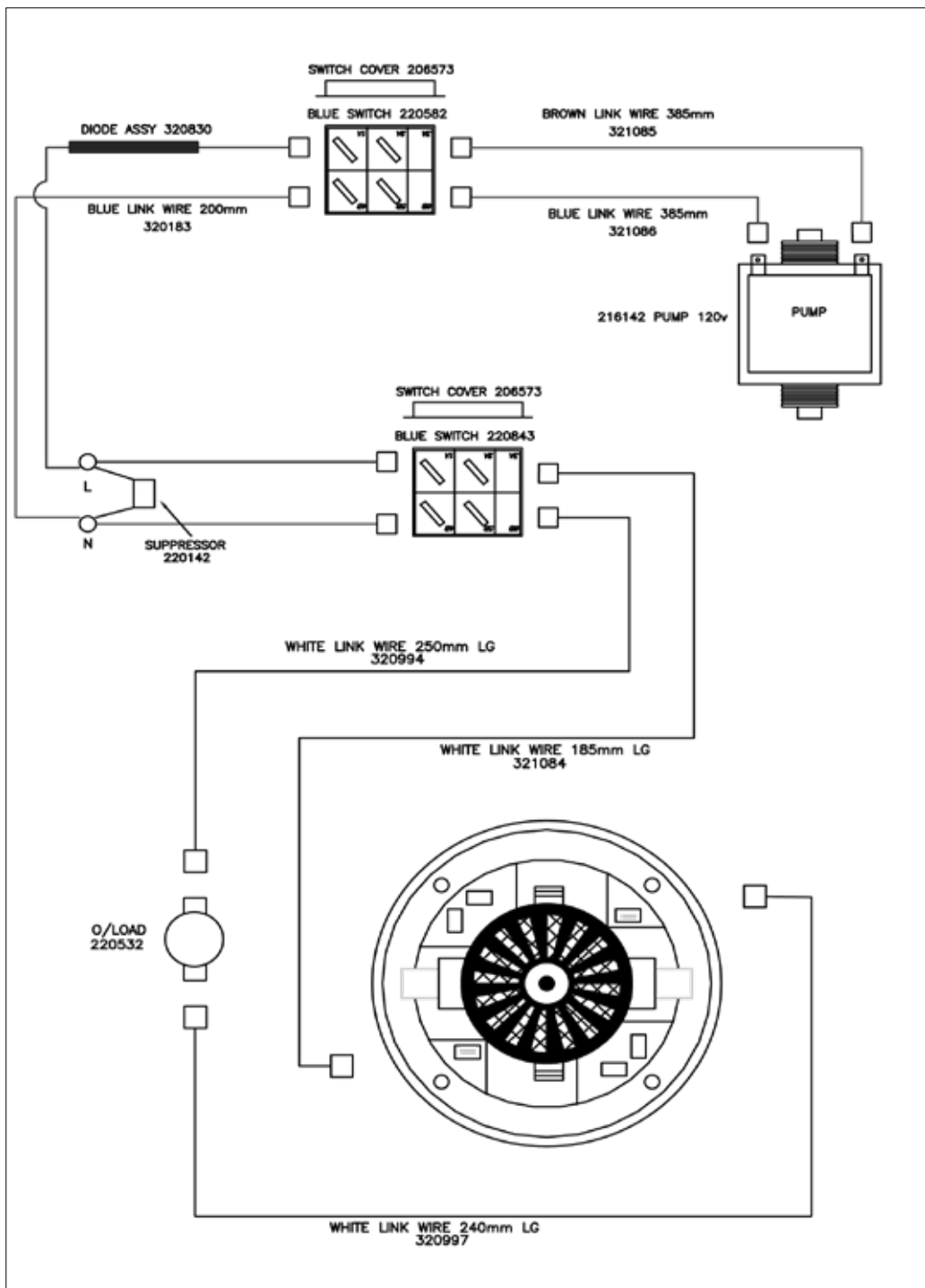

WD-0258 CT 120V (A01)

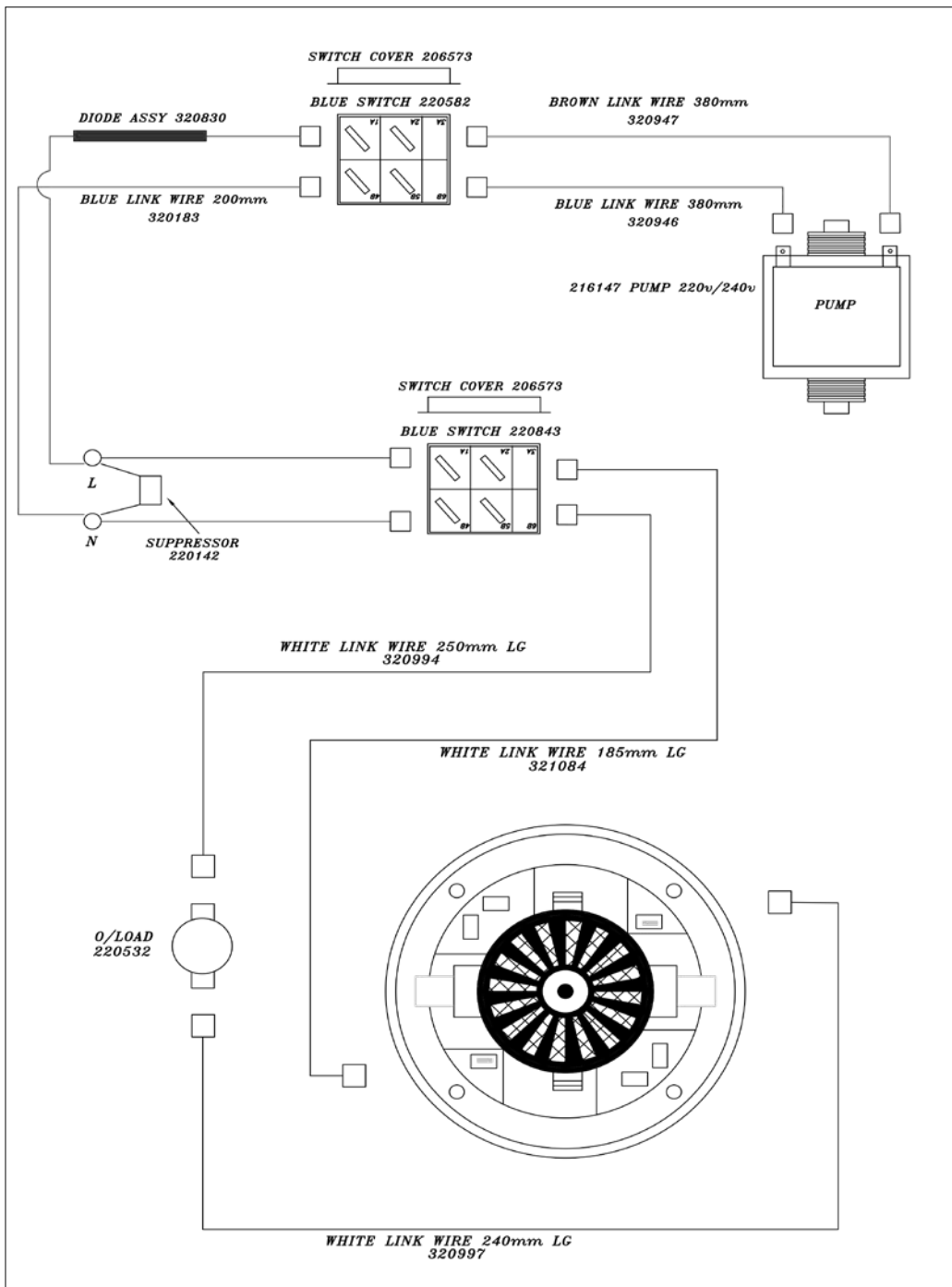

WD-0248 CT 240V (A03)



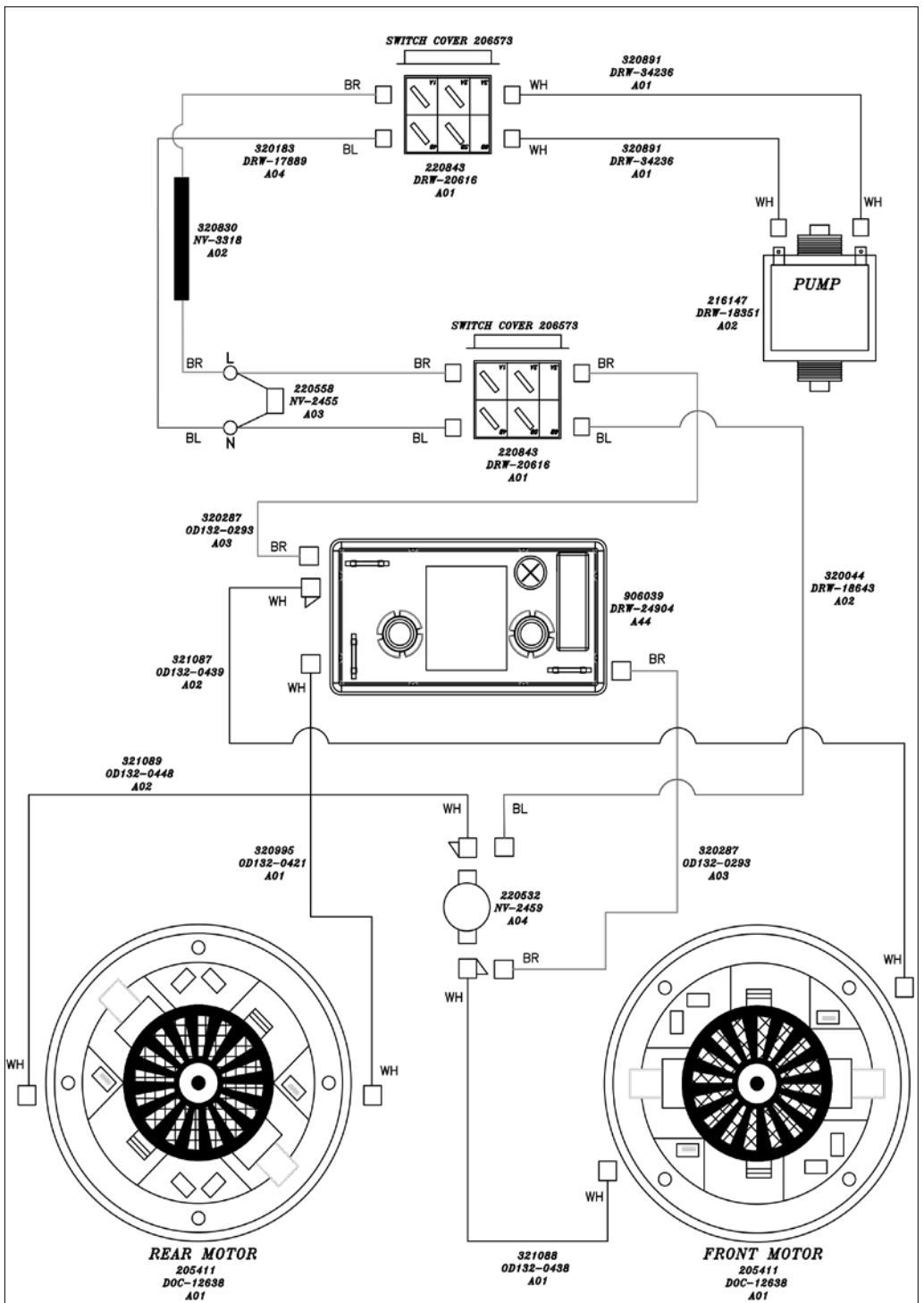

WD-0247 CTD 240V (A10)

# Numatic International Warranty

Numatic International Limited warrant to the original purchaser that its products are free of defects in both material or workmanship for the period shown below:-

Homecare and Cleancare Vacuum cleaners.....	2 Years
Rotary Floor Machines.....	2 Years
Twintec Auto Scrubber Dryer.....	1 Year
Vario Ride-On Scrubber Dryer.....	1 Year / 1500 hours
Mopping, Compacts, Combi and Servocare Products.....	1 Year
Individual Accessories and Spare Parts.....	6 Months

*Note: This warranty expressly excludes consumable parts such as carbon brushes, floor brushes, mops, batteries etc, that are considered replaceable from time to time during the normal working life of the machine.*

*Using non Numatic dustbags can be detrimental to both machine performance and life and may invalidate the Warranty.*

- A. The warranty period commences from the date the goods are purchased.*
- B. All warranty claims must be processed through the Dealer from whom the equipment was purchased. The Dealer will co-operate with the purchaser throughout the warranty claims procedure and will arrange any necessary repairs using genuine Numatic parts.*
- C. If the original Dealer is no longer able to fulfil his obligations please contact Numatic International Limited with full details of the claim and proof of purchase so that this may be processed without delay.*
- D. Any warranty claim can only relate to the specific part that is proven to be at fault and for which a replacement will be supplied but cannot be extended to constitute a claim against the complete machine.*
- E. Numatic International will supply the Dealer with any warranty parts required, subject to the claim being validated, after return of the faulty items in accordance with Numatic International Limited's General Conditions of Sale.*
- F. Claims will not be accepted if they are the result of fair wear and tear, misuse or abuse of any kind.*
- G. No replacement will be given unless the appropriate evidence of the validity of the claim has been provided to the satisfaction of Numatic International Limited.*
- H. Numatic International Limited reserve the right to charge for any unnecessary work carried out as a result of an invalid claim.*
- I. No variation to this warranty may be made or implied by any member of Numatic International Limited or its Dealers unless such variation is in writing and authorised by the Company*

# Numatic

Numatic International Limited. Chard, Somerset, TA20 2GB

Telephone: 01460 68600 Fax: 01460 68458

© Numatic International Limited

<b>UKCA Declaration of Conformity</b>	
<b>Manufacturer:</b>	Numatic International Limited Chard Somerset TA20 2GB www.numatic.co.uk
<b>Product:</b>	CT, CTD
<b>Description:</b>	Vacuum Cleaner – Commercial – Spray Extraction, Wet & Dry
<b>We, Numatic hereby declare under our sole responsibility, that the above-mentioned product(s) is/are in conformity with the following directives and standards.</b>	
S.I. 2008: 1597	Supply of Machinery Regulations EN60335-1:2012 + AC:2014 + A11:2014 + A13:2017 + A15:2021 EN60335-2-69:2012 EN60335-2-68:2012 EN62233:2008
S.I. 2016: 1091	EMC Regulations EN55014-1:2017 + A11:2020 EN55014-2:1997 + A1:2001 + A2:2008 EN61000-3-2:2014 EN61000-3-3:2013
S.I. 2012: 3032	RoHS Regulations

Authorised Signatory: Mr. Matthew Coles

Position: Head of Technology

Signed: *M Coles* Date: 30<sup>th</sup> Aug 2023

Numatic International Limited,  
Chard,  
Somerset, TA20 2GB, UK

DEC-002 V2.1

EU, EC, UK, UK ES: <b>Declaration of Conformity</b> Konformitäterklärung Overensstemmelseserklæring Vastavuorentunnustaan Déclaration de conformité	Декларация на соответствие Δήλωση συμμόρφωσης Мгэгтлэгдэлг нийтэлцээт Dichiarazione di conformità Atkertes deklarácia Samsvareklæring Samsvarserklæring Déclaration de conformité	Декларация на соответствие Dichiarazione di conformità Atkertes deklarácia Samsvareklæring Déclaration de conformité	 Numatic International Limited Chard Somerset TA20 2GB www.numatic.co.uk CT, CTD
<b>GB We, Numatic hereby declare under our sole responsibility, that the above-mentioned product(s) is/are in conformity with the following directives and standards.</b> CZ My, Numatic prohlašujeme našou samostatnou odpověď za celou odpověď, že naše výrobky je ve shodě s následujícími směrnici a normami. DE Wir, Numatic erklären in alleiniger Verantwortung, dass das oben genannte Produkt den folgenden Richtlinien und Normen entspricht. DK Vi, Numatic erklærer hermed under vores ene og udelte ansvar, at vores produkt overensstemmelser med følgende direktiver og standarder. ES Nosotros, Numatic declaramos bajo nuestra única responsabilidad que el producto mencionado está en conformidad con las siguientes directivas y normas. EE Meie, Numatic kätsetsevad kiitavalt ja kindlalt vastutuse eest, et eespool nimetatud toode on kooskõlas järgmistega standardite ja normidega. FR Numatic déclare sous notre seule responsabilité, que le produit mentionné est conforme aux directives et normes suivantes.	BG Ние, Numatic С изцяло наша отговорност, че посоченото по-горе продуктите е в съответствие със следните директиви и стандарти. GR Εμείς, Numatic δηλώνουμε με αποκλειστική ευθύνη και αποκλειστική ευθύνη, ότι το παραπάνω προϊόν πεπληρωμένο με τις απαιτήσεις οδηγίες και πρότυπων. HU Mi, Numatic kijelentjük, egyedül felelősséggel, hogy a fent említett termék megfelel a következő előírásoknak és szabványoknak. IT Noi, Numatic dichiaro sotto la propria responsabilità, che il prodotto di cui sopra è conforme alle seguenti direttive e norme. LT Mes, Numatic pareiški vienišališkis atsakomybę, kad pirmiau minėtas produktas atitinka šias direktyvas ir standartus. NL Wij verklaren Numatic hereby de eigen verantwoordelijkheid, dat het bovengenoemde product voldoet aan de volgende richtlijnen en normen. NO Vi, Numatic erklærer herved under eget ansvar, at det ovennevnte produktet er i samsvar med følgende direktiver og standarder.	PT Nós, Numatic declaramos, sob nossa exclusiva responsabilidade, que o produto acima mencionado está em conformidade com as diretrizes e normas a seguir. PL My, Numatic ninajemy odpowiedzialność z własną odpowiedzialnością, że powyższe wymienione produkty spełniają wymagania następujących dyrektyw i normami. RO Noi, Numatic prin prezenta declarații ne asumăm exclusiv răspunderea, că produsul menționat este în conformitate cu normele stabilite în directivele și standardele. RU Мы, Numatic, берем на себя полную и исключительную ответственность за соответствие нашего продукта следующим директивам и нормам. SE Vi Numatic förklarar, härmed under eget ansvar att ovan nämnda produkt överensstämmer med följande direktiv och normer. SI Mi, Numatic izjavljamo s polno odgovornostjo, da je zgoraj omeneni izdelek v skladu s naslednjimi smernicami in standardi. FI Me, Numatic täten vastuuttamme omalla vastuulla, että edellä mainittu tuote on täysin yhtäpitäinen edellä mainittujen ja standardien mukaisesti!	
<b>2014/30/UE</b>	<b>EMC Directive</b>	<b>EN55014-1:2017 + A11:2020</b> <b>EN55014-2:1997 + A1:2001 + A2:2008</b> <b>EN61000-3-2:2014</b> <b>EN61000-3-3:2013</b>	<b>2006/42/EC</b> <b>Machinery Directive</b> <b>A15:2021</b> <b>EN60335-2-69:2012</b> <b>EN60335-2-68:2012</b> <b>EN55014-1:2017 + A11:2020</b> <b>EN55014-2:1997 + A1:2001 + A2:2008</b> <b>EN61000-3-2:2014</b> <b>EN61000-3-3:2013</b>
<b>2011/65/UE</b>	<b>RoHS Directive</b>		<b>2006/42/EC</b> <b>Machinery Directive</b> <b>A15:2021</b> <b>EN60335-2-69:2012</b> <b>EN60335-2-68:2012</b> <b>EN55014-1:2017 + A11:2020</b> <b>EN55014-2:1997 + A1:2001 + A2:2008</b> <b>EN61000-3-2:2014</b> <b>EN61000-3-3:2013</b>

Authorised Signatory: Mr. Matthew Coles

Position: Head of Technology

Signed: *M Coles* Date: 30<sup>th</sup> August 2023

Numatic International Limited  
Chard,  
Somerset, TA20 2GB, UK

DEC-002 V3.2

# Numatic

numatic.com

## **Numatic International Limited (Head Office)**

Chard, Somerset TA20 2GB, UNITED KINGDOM

Tel: 01460 68600 numatic.com

## **Numatic International GmbH**

Fränkische Straße 15-19, 30455 Hannover, DEUTSCHLAND

Tel: +49 (0) 511 984 2160 numatic.de

## **Numatic International Denmark**

Fränkische Straße 15-19, 30455 Hannover, DEUTSCHLAND

Tel: +45 (0) 316 40808 numatic-online.dk

## **Numatic International S.A.S**

13/17 rue du Valengelier, EAE la Tuilerie, 77500 Chelles, FRANCE

Tel: +33 (0) 164 726 161 numatic.fr

## **Numatic International BV**

Vennootsweg 15, 2404 CG, Alphen aan den Rijn, NEDERLAND

Tel: +31 (0) 172 467 999 numatic.nl

## **Numatic International Schweiz AG.**

Sihlbruggstrasse 3A, 6340 Baar, SCHWEIZ

Tel: +41 (0) 41 768 0760 numatic.ch

## **Numatic International (PTY) Ltd.**

Cnr. 16th & Pharmaceutical Road, Randjes Park, Midrand 1685, SOUTH AFRICA

Tel: +27 (0) 861 686 284 numatic.co.za

## **Numatic International ULDA**

Rua da Boa Viagem, 177, 4470 - 210 Moreira Maia, PORTUGAL

Tel: +351 220 047 700 numatic.pt

## **Numatic International SLU**

Delegación de CATALUÑA-BARCELONA, PZ LETAMENDI, 13, 08007 Barcelona, SPAIN

Tel: +34 901 200 350 numatic.es

## **Numatic International Italy S.R.L**

Via Luigi Galvani, 2, Z.I. Talponedo, 33080 Porcia (PN), ITALY

Tel: +39 (0) 434 046 211 numatic.it